

Estate

Use And Care

G U I D E

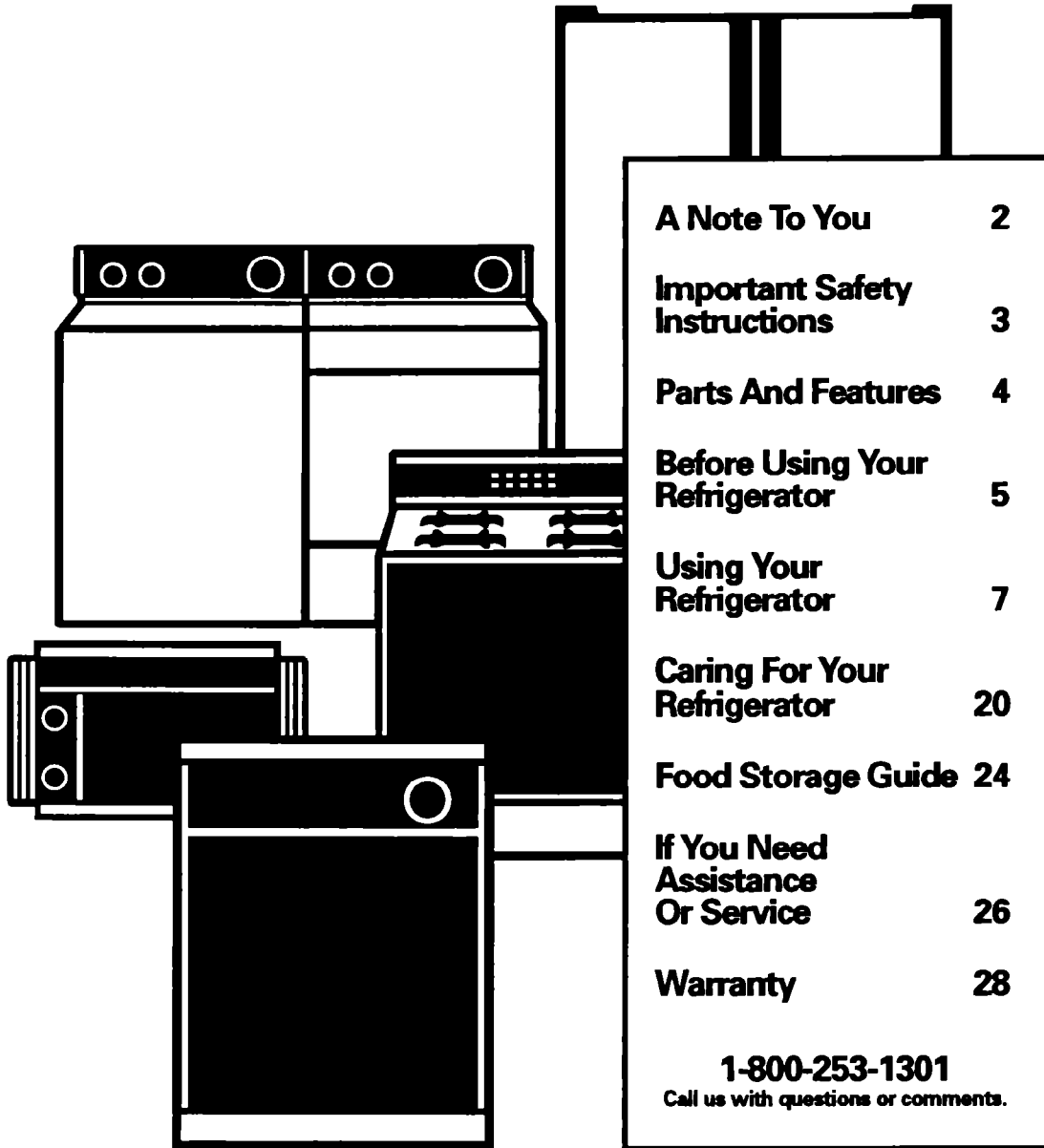

NO-FROST REFRIGERATOR-FREEZER

B

MODEL TS25AQ

2/94

A NOTE TO YOU

A Note To You

Thank you for buying an Estate® appliance.

You purchased a quality, *world-class* home appliance. Years of engineering experience went into its manufacturing. To ensure that you enjoy many years of trouble-free operation, we developed this Use and Care Guide. It is full of valuable information on how to operate and maintain your appliance properly and safely. Please read it carefully. Also, please complete and mail the Ownership Registration Card provided with your appliance. This will help us notify you about any new information on your appliance.

Your safety is important to us.

This guide contains safety symbols and statements. Please pay special attention to these symbols and follow any instructions given. Here is a brief explanation of the use of each symbol.

WARNING

This symbol will help alert you to such dangers as personal injury, burns, fire and electrical shock.

CAUTION

This symbol will help you avoid actions which could cause product damage (scratches, dents, etc.) and damage to your personal property.

Our Consumer Assistance Center number, 1-800-253-1301, is toll-free, 24 hours a day.

If you ever have a question concerning your appliance's operation, or if you need service, first see "If You Need Assistance Or Service" on page 26. If you need further help, feel free to call our Consumer Assistance Center. When calling, you will need to know your appliance's complete model number and serial number. You can find this information on the model and serial number label (see diagram on page 4). For your convenience, we have included a handy place below for you to record these numbers, the purchase date from the sales slip and your dealer's name and telephone number. Keep this book and the sales slip together in a safe place for future reference.

Model Number _____

Dealer Name _____

Serial Number _____

Dealer Phone _____

Purchase Date _____

Important Safety Instructions

⚠ WARNING

To reduce the risk of fire, electrical shock, or injury when using your refrigerator, follow these basic precautions:

- Read all instructions before using the refrigerator.
 - Child entrapment and suffocation are not problems of the past. Junked or abandoned refrigerators are still dangerous ... even if they will “just sit in the garage a few days.”
If you are getting rid of your old refrigerator, do it safely.
 - Never allow children to operate, play with, or crawl inside the refrigerator.
 - Never clean refrigerator parts with flammable fluids. The fumes can create a fire hazard or explosion.
 - FOR YOUR SAFETY •
- DO NOT STORE OR USE GASOLINE OR OTHER FLAMMABLE VAPORS AND LIQUIDS IN THE VICINITY OF THIS OR ANY OTHER APPLIANCE. THE FUMES CAN CREATE A FIRE HAZARD OR EXPLOSION.**

– SAVE THESE INSTRUCTIONS –

Help us help you

Please:

- Install and level the refrigerator on a floor that will hold the weight and in an area suitable for its size and use.
- Do not install the refrigerator near an oven, radiator or other heat source.
- Do not use the refrigerator in an area where the room temperature will fall below 55°F (13°C).
- Keep the refrigerator out of the weather.
- Connect the refrigerator only to the proper kind of outlet, with the correct electrical supply and grounding.
- Do not load the refrigerator with food before it has time to get properly cold.
- Use the refrigerator only for the uses described in this manual.
- Properly maintain the refrigerator.
- Be sure the refrigerator is not used by anyone unable to operate it properly.

PARTS AND FEATURES

Parts And Features

This section contains captioned illustrations. Use them to become familiar with where all parts and features are located and what they look like.

Control panel

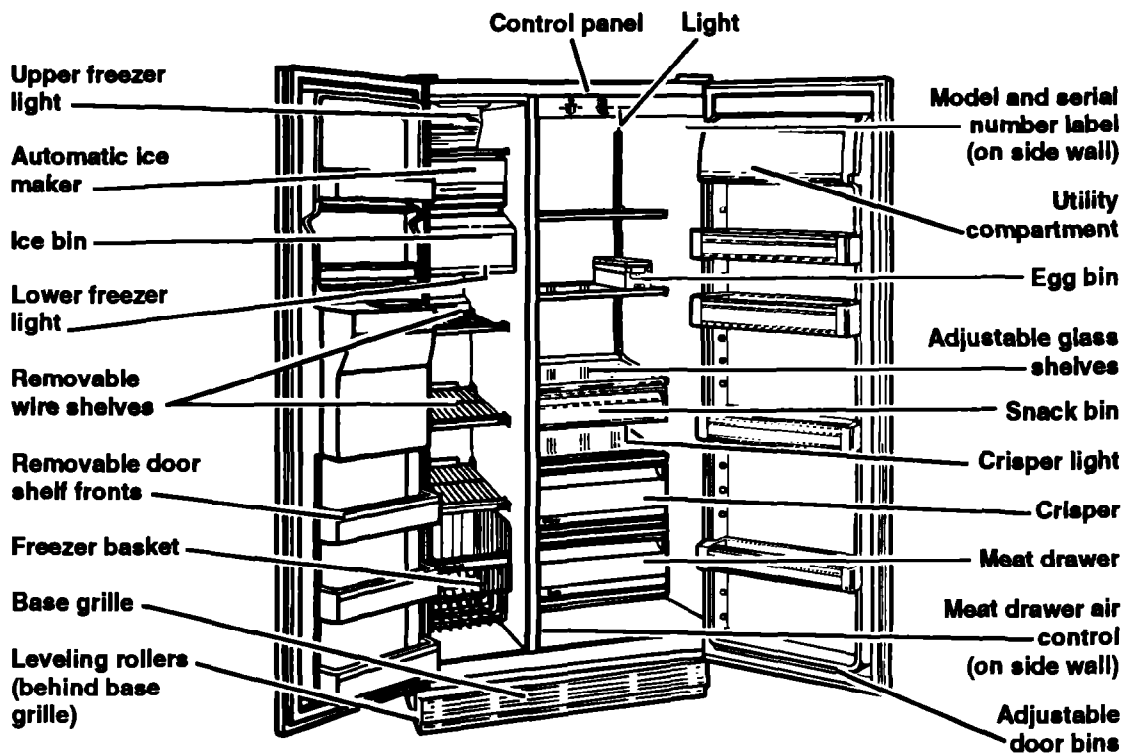
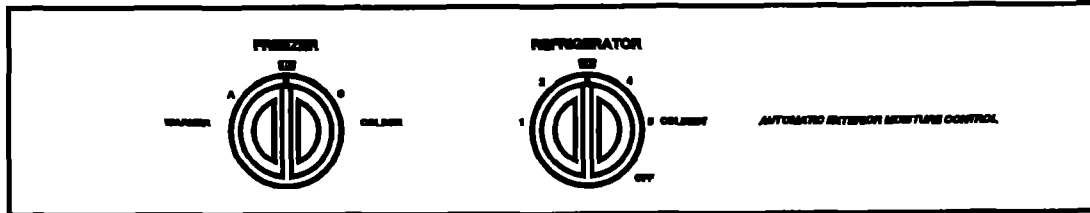

Before Using Your Refrigerator

In This Section		Page	Page
Cleaning It	5	Installing It properly	6
Plugging It In	5	Leveling It	6

It is important to prepare your refrigerator for use. This section tells you how to clean it, connect it to a power source, install it and level it.

Cleaning it

Removing packaging materials

Remove tape and any inside labels (except the model and serial number label) before using the refrigerator.

To remove any remaining glue:

- Rub briskly with thumb to make a ball, then remove.

OR

- Soak area with liquid hand-dishwashing detergent before removing glue as described above. Do not use sharp instruments, rubbing alcohol, flammable fluids or abrasive cleaners. These can damage the material. See "Important Safety Instructions" on page 3.

NOTE: Do not remove any permanent instruction labels inside your refrigerator. Do not remove the Tech Sheet fastened under the refrigerator at the front.

Cleaning it before use

After removing all packaging materials, clean your refrigerator before using it, if necessary. See cleaning instructions on pages 20-21.

Plugging it in

Recommended Grounding Method

A 115 Volt, 60 Hz., AC only 15 or 20 ampere fused and properly grounded electrical supply is required. It is recommended that a separate circuit serving only this appliance be provided. Use a receptacle which cannot be turned off with a switch or pull chain. Do not use an extension cord.

See Electrical Requirements and Grounding Instructions Sheet in your Literature Package.

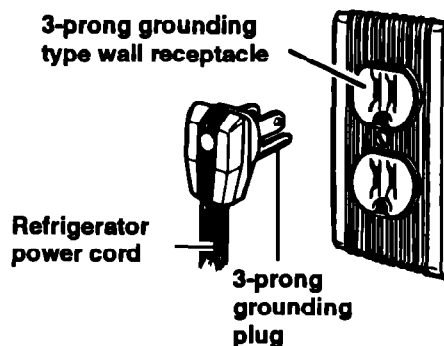

BEFORE USING YOUR REFRIGERATOR

Installing it properly

1. Allow ½ inch (1.25 cm) space on each side and at the top of the refrigerator for ease of installation.
2. If the refrigerator is to be against a wall, you might want to leave extra space on the hinge side closest to the wall so the door can be opened wider.
3. The refrigerator can be flush against the wall.

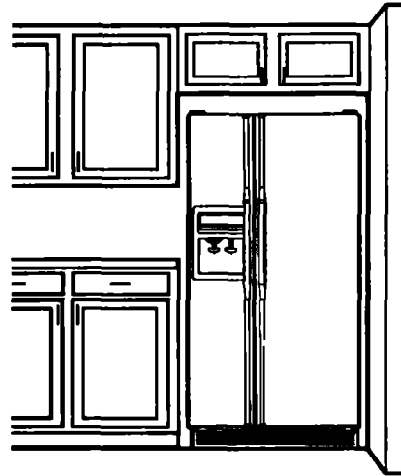

Leveling it

Your refrigerator has 2 front leveling screws—one on the right and one on the left. To adjust one or both of these, follow the directions below.

1. Remove base grille. (See page 17.)
2. To raise front, turn screw clockwise.
3. To lower front, turn screw counterclockwise.
4. Check with level.
5. Replace base grille. (See page 17.)

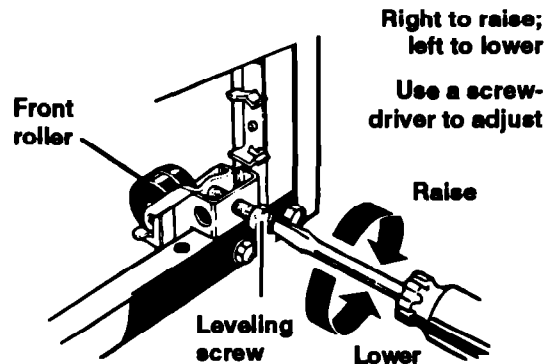

Using Your Refrigerator

In This Section		Page	Page
Setting the controls	7	Removing the freezer shelves	12
Changing the control settings	8	Using the ice and water dispensers	12
Removing the door shelf fronts	9	Using the automatic ice maker	14
Removing the door trim	9	Removing the ice maker storage bin	15
Adjusting the door bins	9	Solving common ice maker/dispenser problems	16
Adjusting the refrigerator shelves ..	10	Removing the base grille	17
Removing the snack bin	10	Changing the light bulbs	17
Removing the crisper and crisper cover	10	Understanding the sounds you may hear	19
Removing the meat drawer and cover	11	Saving energy	19
Adjusting the meat drawer temperature	11		
Removing the freezer basket	11		

To obtain the best possible results from your refrigerator, it is important that you operate it properly. This section tells you how to set the controls, remove and adjust some of the features in your refrigerator, and how to save energy.

Setting the controls

Controls for the refrigerator and freezer are in the refrigerator. When you plug in the refrigerator for the first time:

- Set the Refrigerator Control to 3.**
Refrigerator Control adjustments range from 1 (warmest) to 5 (coldest).

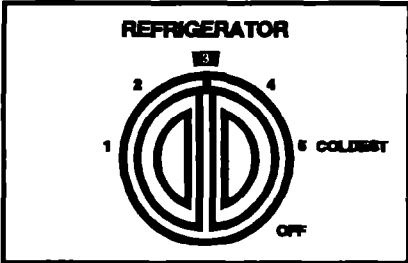

- Set the Freezer Control to B.**
Freezer Control adjustments range from A (warmest) to C (coldest).

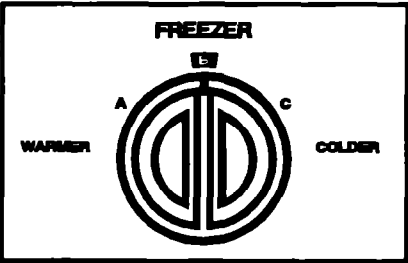

USING YOUR REFRIGERATOR

3. Give the refrigerator time to cool down completely before adding food. This may take several hours.

The settings indicated above should be correct for normal, household refrigerator usage. The controls are set correctly when milk or juice is as cold as you like and when ice cream is firm. If you need to adjust these settings, see "Changing the control settings" below.

NOTE: The Automatic Exterior Moisture control continuously guards against moisture build-up on the outside of your refrigerator cabinet. This control does not have to be set or adjusted.

Changing the control settings

If you need to adjust temperatures in refrigerator or freezer, use the settings listed in the chart below as a guide. If you have questions, call our Consumer Assistance Center number, 1-800-253-1301.

- Adjust the Refrigerator Control first.
- Wait at least 24 hours between adjustments.
- Then adjust the Freezer Control if needed.

CONDITION:	REASON:	RECOMMENDED CONTROL SETTINGS:
Refrigerator section too warm	<ul style="list-style-type: none"> • Door opened often • Large amount of food added • Room temperature too warm 	Refrigerator 4 Freezer A
Freezer section too warm	<ul style="list-style-type: none"> • Door opened often • Large amount of food added • Very cold room temperature (can't cycle often enough) 	Refrigerator 3 Freezer C
Refrigerator section too cold	<ul style="list-style-type: none"> • Controls not set correctly for your conditions 	Refrigerator 2 Freezer B
Ice not made fast enough	<ul style="list-style-type: none"> • Heavy ice usage • Very cold room temperature (can't cycle often enough) 	Refrigerator 3 Freezer C
Both sections too warm	<ul style="list-style-type: none"> • Door opened often • Large amount of food added • Very warm or very cold room temperatures 	Refrigerator 4 Freezer B

Removing the door shelf fronts

Remove the door shelf fronts for easier cleaning.

To remove shelf fronts:

1. Remove all items from the shelf.
2. Pull out on the inside tab at each end of the shelf front.
3. Pull shelf front straight out.

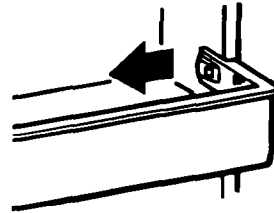

To replace shelf fronts:

1. Line up each end of the shelf front with the button on the door liner wall.
2. Push shelf front straight back until it snaps securely into place.
3. Replace items on the shelf.

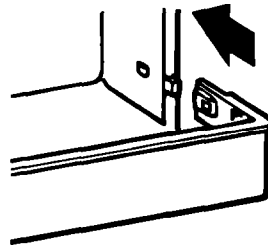

Removing the door trim (dispenser area)

Remove the trim above the dispenser area for easier cleaning.

To remove trim:

1. Remove all items from the shelf.
2. Pull straight up at each end of the trim.

To replace trim:

1. Line up each end of the trim above the trim pocket opening in the door liner wall.
2. Push the trim straight down until it stops.
3. Replace items on the shelf.

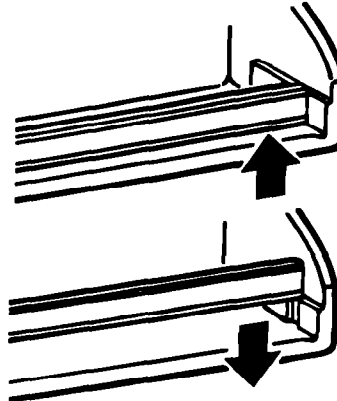

Adjusting the door bins

To remove door bins:

1. Lift bin up.
2. Pull bin straight out.

To replace door bins:

1. Slide bin in above desired support button.
2. Push down until it stops.

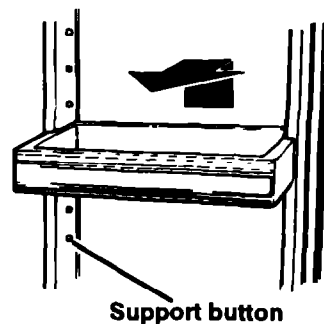

Adjusting the refrigerator shelves

Adjust the shelves to match the way you use your refrigerator. Glass shelves are strong enough to hold bottles, milk, and other heavy food items.

To remove the shelves:

1. Remove items from the shelf.
2. Tilt shelf up at front.
3. Lift shelf up at back.
4. Pull shelf straight out.

To replace the shelves:

1. Guide the rear shelf hooks into the slots in the shelf supports on the back liner wall.
2. Tilt front of shelf up until hooks drop into slots.
3. Lower front of shelf to a level position.

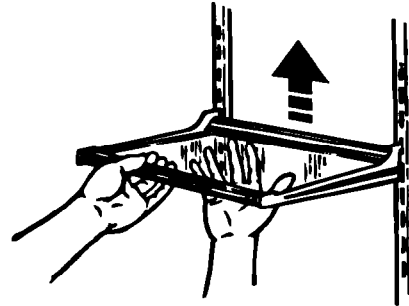

Glass shelves are heavy. Be careful.

Removing the snack bin

To remove the snack bin:

1. Slide snack bin straight out to the stop with an even, constant motion.
2. Lift the front.
3. Slide bin out the rest of the way.
4. Replace in reverse order.

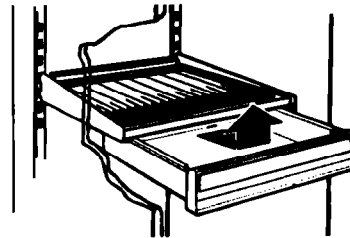

Removing the crisper and crisper cover

To remove the crisper:

1. Slide the crisper straight out to the stop.
2. Lift the front slightly.
3. Slide out the rest of the way.
4. Replace in reverse order.

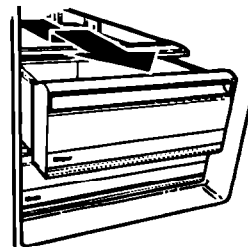

Pull out to the stop, lift the front and pull again.

To remove the cover:

1. Hold cover firmly with both hands and lift front of cover off supports.
2. Lift cover out by pulling up and out.

To replace the cover:

1. Fit back of cover into notch supports on walls of refrigerator.
2. Lower front into place.

Lift the cover front, then the back.

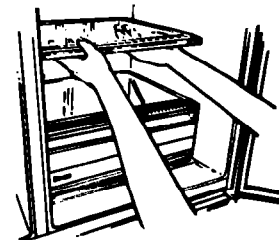

Removing the meat drawer and cover

To remove the meat drawer:

1. Slide the meat drawer straight out to the stop.
2. Lift the front slightly.
3. Slide out the rest of the way.
4. Replace in reverse order.

To remove the cover:

1. Remove the crisper, the crisper cover and the meat drawer.
2. Tilt front of cover up.
3. Lift cover at back and pull straight out.
4. Replace in reverse order.

Pull out to the stop, lift the front and pull again.

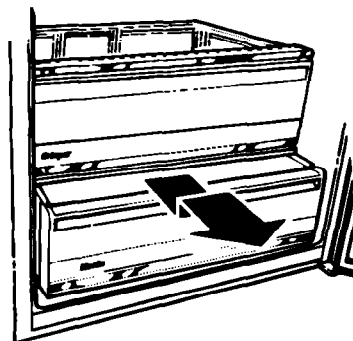

Adjusting the meat drawer temperature

Cold air flows against the meat drawer through an opening between the freezer and the refrigerator. This helps keep the meat drawer colder than the rest of the refrigerator for better storage of meats.

Slide the control to let more or less cold air through.

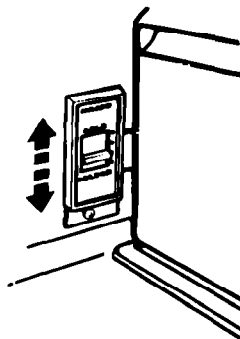

Removing the freezer basket

To remove the basket:

1. Slide out to the stop.
2. Lift the front to clear the stop.
3. Slide out the rest of the way.

To replace the basket:

1. Place on the slides.
2. Make sure the wire stops clear the front of the slides.
3. Slide in all the way.

Pull out to the stop, lift the front and pull again.



USING YOUR REFRIGERATOR

Removing the freezer shelves

To remove the shelf:

1. Lift right side of shelf off supports.
2. Slide shelf out of shelf support holes.
3. Replace in reverse order.

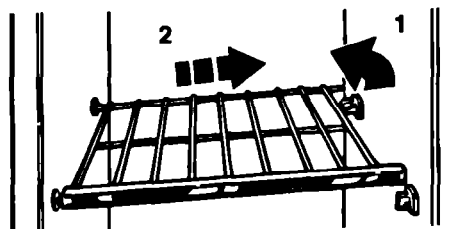

Using the ice and water dispensers

⚠ WARNING

Personal Injury Hazard

Tumbling ice and pressure can break a fragile glass. Use a sturdy glass when dispensing ice or water.

Failure to do so could result in personal injury or breakage.

Ice dispenses from the ice maker storage bin in the freezer. When you press the dispenser bar, a trapdoor opens in a chute between the dispenser and the ice bin. Ice moves from the bin and falls through the chute. When you release the dispenser bar, a buzzing sound may be heard for a few seconds as the trapdoor closes. The dispenser system will not operate when the freezer door is open.

For crushed ice, cubes are crushed before being dispensed. This may cause a slight delay when dispensing crushed ice. Noise from the ice crusher is normal, and pieces of ice may vary in size.

When changing from CRUSHED to CUBE, a few ounces of crushed ice will be dispensed along with the first cubes.

To dispense ice:

1. For cubed ice, move Ice Selector Switch to CUBE position.
2. For crushed ice, move Ice Selector Switch to CRUSHED position.

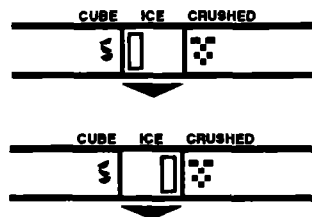

USING YOUR REFRIGERATOR

2. Press a **sturdy** glass against the ice dispenser bar. Hold glass close to dispenser opening so ice does not fall outside of glass.
3. Remove the glass to stop dispensing.

NOTE: The first few batches of ice may have an off-flavor from new plumbing and parts. Throw the ice away. Also, take large amounts of ice from the ice bin, not through the dispenser.

The water dispenser

Chilled water comes from a tank behind the meat drawer. It holds approximately 1½ quarts (1.5 L).

When the refrigerator is first hooked up, press the water dispenser bar with a sturdy glass or jar until you draw and discard 2 to 3 quarts (1.9 to 2.8 L). The water you draw and discard rinses the tank and pipes.

Allow several hours to chill a new tankful.

NOTE: The small tray beneath the dispenser is designed to evaporate **small** spills. There is no drain in this tray. **Do not** pour water into it.

To dispense water:

1. Press a **sturdy** glass against the water dispenser bar.
2. Remove the glass to stop dispensing.

NOTE: Dispense enough water every week to maintain a fresh supply.



Using the automatic ice maker

Here are a few things you will want to know about your automatic ice maker:

- The ON/OFF lever is a wire signal arm.
DOWN to make ice automatically.
UP to shut off the ice maker.

NOTE: Do not turn ice maker on until it is connected to the water supply. **Instructions for ice maker water supply hook up are attached to the back of the refrigerator cabinet.**

- It is normal for ice crescents to be attached by a corner. They break apart easily.
- The ice maker will not operate until the freezer is cold enough to make ice. This can take overnight.
- If ice is not being made fast enough and more ice is needed, turn the Refrigerator Control toward a higher number. Wait a day and, if necessary, turn the Freezer Control toward C.
- Good water quality is important for good ice quality. Try to avoid connecting the ice maker to a softened water supply. Water softener chemicals (such as salt from a malfunctioning softener) can damage the ice maker mold and lead to poor ice quality. If a softened water supply cannot be avoided, make sure the water softener is operating properly and well maintained.

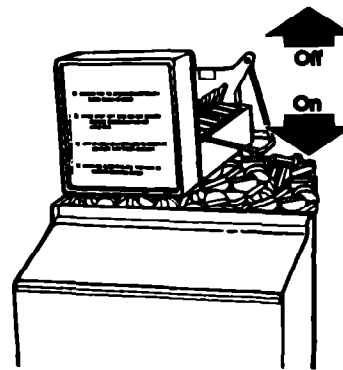

UP to
stop ice
maker.

DOWN to
start ice
maker.

Removing the ice maker storage bin

Remove, empty and clean the storage bin if:

- the ice dispenser has not, or will not, be used for a week or more.
- a power failure causes ice in the bin to melt and freeze together.
- the ice dispenser is not used regularly.

To remove ice bin:

1. Pull the covering panel out from the bottom and slide it to the rear.

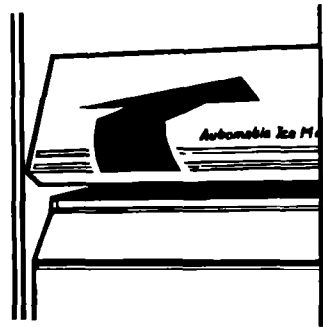

2. Lift the signal arm so it clicks into the OFF (up) position. Ice can still be dispensed, but no more can be made.

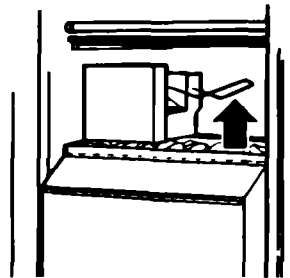

3. Lift the front of the storage bin and pull it out.
4. Empty the ice bin. Use hot or warm water to melt the ice if necessary. **Never use anything sharp** to break up ice in the bin. This can damage the bin and dispenser mechanism.
5. Wash with mild detergent. Rinse well. Do not use harsh or abrasive cleaners or solvents.
6. When replacing the bin, make sure it is pushed in all the way. Then push the signal arm down to the ON position to restart ice production.

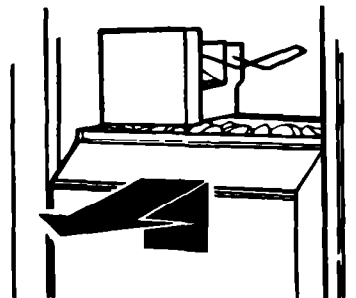

Solving common ice maker/dispenser problems

PROBLEM	CAUSE	SOLUTIONS
Ice dispenser won't work	<ul style="list-style-type: none"> • Freezer door open • Ice bin not properly installed • Wrong ice in bin • Dispenser not used for extended periods, causing ice cubes to melt together 	<ul style="list-style-type: none"> • Close the freezer door. • Make sure bin is pushed in all the way. • Use only crescents from ice maker. Shake the bin occasionally to keep cubes separated and to increase storage room. • Dump old ice and make a new supply.
Ice dispenser stops working	<ul style="list-style-type: none"> • Ice dispenser bar held in too long 	<ul style="list-style-type: none"> • Wait about 3 minutes for the dispenser motor to reset. • Large amounts of ice should be taken from the bin, not through the dispenser.
Off-taste or odor in ice	<ul style="list-style-type: none"> • Ice attracts airborne odors; old ice • Water quality • Foods not properly wrapped • Ice bin and freezer may need cleaning • Plumbing to ice maker • New ice maker 	<ul style="list-style-type: none"> • Dump old ice and make a new supply. Store excess ice in covered container. • Water containing minerals (such as sulfur) may require a filter to remove. • Wrap properly. See pages 24 and 25. • Clean freezer and ice bin. See cleaning chart on pages 20 and 21. • Follow Installation Instructions for proper ice maker water supply hook up. (See back of refrigerator cabinet.) • The first few loads of ice from a new ice maker may have an off-taste. Dump ice and make a new supply.

Removing the base grille

To remove the grille:

1. Open both doors.
2. Pull base grille forward to release the support tabs from the metal clips.
3. Do not remove Tech Sheet fastened behind the grille.

To replace the grille:

1. Line up grille support tabs with metal clips.
2. Push firmly to snap into place.
3. Close the doors.

See cleaning instructions for defrost pan and condenser coils on page 21.

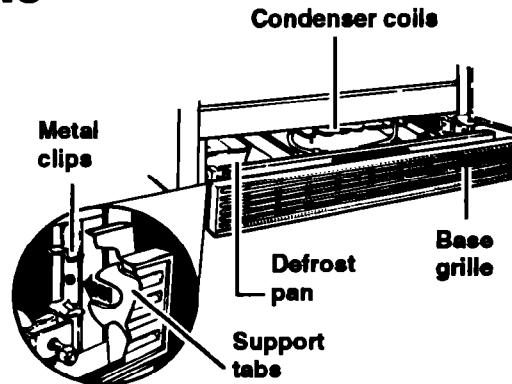

Changing the light bulbs

⚠ WARNING

Electrical Shock Hazard

Before removing a light bulb, either unplug the refrigerator or disconnect the electricity leading to it at the main power supply.

Failure to do so could result in personal injury.

To change refrigerator light:

1. Disconnect refrigerator from power supply.
2. Reach behind the Control Console to remove bulb.
3. Replace bulb with a 40-watt appliance bulb.
4. Reconnect refrigerator to power supply.

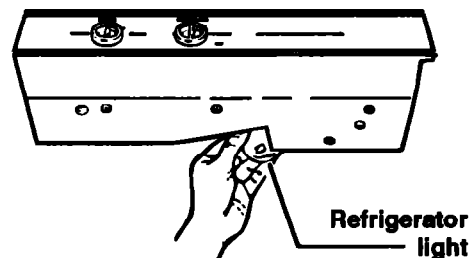

continued on next page

USING YOUR REFRIGERATOR

To change crisper light:

1. Disconnect refrigerator from power supply.
2. Pull top of light shield forward until it snaps free.
3. Lower light shield to clear bottom supports.
4. Pull light shield straight out to remove.
5. Replace bulb with a 40-watt appliance bulb.
6. Replace light shield in reverse order.
7. Reconnect refrigerator to power supply.

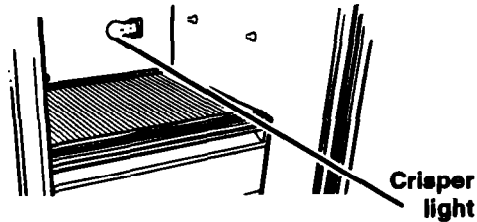

To change the upper freezer light:

1. Disconnect refrigerator from power supply.
2. Lift top of light shield up and pull shield out.
3. Replace bulb with a 40-watt appliance bulb.
4. Place light shield over bulb and snap shield into place.
5. Reconnect refrigerator to power supply.

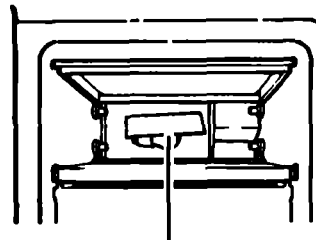

To change lower freezer light:

1. Disconnect refrigerator from power supply.
2. Push in sides of light shield until it snaps free.
3. Replace bulb with a 40-watt appliance bulb.
4. Replace light shield.
5. Reconnect refrigerator to power supply.

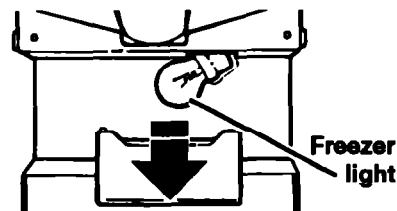

NOTE: Not all appliance bulbs will fit your refrigerator. Be sure to replace a bulb with one of the same size and shape.

Understanding the sounds you may hear

Your new refrigerator may make sounds that your old one didn't. Because the sounds are new to you, you might be concerned about them. Don't be. Most of the new sounds are normal. Hard surfaces like the floor, walls and cabinets can make the sounds seem louder.

The following describes the kinds of sounds that might be new to you, and what may be making them.

Slight hum, soft hiss

You may hear the refrigerator's fan motor and moving air.

Clicking or snapping sounds

The thermostat makes a definite click when the refrigerator stops running. It also makes a sound when the refrigerator starts. The defrost timer will click when the defrost cycle starts.

Water sounds

When the refrigerator stops running, you may hear gurgling in the tubing for a few minutes after it stops. You may also hear defrost water running into the defrost water pan.

Ice maker sounds

- trickling water
- thud (clatter of ice)

You may hear buzzing (from the water valve), trickling water and the clatter of ice dumped into the bin.

Running sounds

Your refrigerator has a high-efficiency compressor and motor. It will run longer than older designs. It may even seem to run most of the time.

Saving energy

You can help your refrigerator use less electricity.

- Check door gaskets for a tight seal. Level the cabinet to be sure of a good seal.
- Clean the condenser coils regularly.
- Open the door as few times as possible. Think about what you need before you open the door. Get everything out at one time. Keep food organized so you won't have to search for what you want. Close door as soon as food is removed.
- Go ahead and fill up the refrigerator, but don't overcrowd it so air movement is blocked.
- It is a waste of electricity to set the refrigerator and freezer to temperatures colder than they need to be. If ice cream is firm in the freezer and drinks are as cold as your family likes them, that's cold enough.
- Make sure your refrigerator is not next to a heat source such as a range, water heater, furnace, radiator or in direct sunlight.

Caring For Your Refrigerator

In This Section	Page	Page	
Cleaning your refrigerator	20	Power interruptions	23
Vacation and moving care	22		

Your refrigerator is built to give you many years of dependable service. However, there are a few things you can do to help extend its product life. This section tells you how to clean your refrigerator and what to do when going on vacation, moving or during a power outage.

Cleaning your refrigerator

Both the refrigerator and freezer sections defrost automatically. However, clean both about once a month to prevent odors from building up. Wipe up spills right away.

To clean your refrigerator, turn the Refrigerator Control to OFF, unplug it, take out all removable parts and clean the refrigerator according to the following directions.

⚠ WARNING

Personal Injury Hazard

Refrigeration system tubes are located near the defrost pan and can become hot. Remove and install defrost pan carefully.

Failure to do so could result in personal injury.

PART	WHAT TO USE	HOW TO CLEAN
Removable parts (shelves, crisper, etc.)	Sponge or cloth with mild detergent and warm water	<ul style="list-style-type: none"> • Hand wash, rinse and dry thoroughly.
Outside	Sponge, cloth or paper towel with mild detergent, warm water and an appliance wax (or good auto paste wax)	<ul style="list-style-type: none"> • Wash outside of cabinet. Do not use abrasive or harsh cleaners. • Rinse and dry thoroughly. • Wax painted metal surfaces at least twice a year. Apply wax with a clean, soft cloth. Waxing painted metal surfaces provides rust protection. Do not wax plastic parts.
Inside walls (allow freezer to warm up so cloth won't stick)	Sponge, soft cloth or paper towel with baking soda or mild detergent and warm water	<ul style="list-style-type: none"> • Wash with mixture of warm water and: <ul style="list-style-type: none"> – mild detergent, or – baking soda (2 tablespoons [26 g] to 1 quart [.95 L] of water). • Rinse and dry thoroughly.

CARING FOR YOUR REFRIGERATOR

PART	WHAT TO USE	HOW TO CLEAN
Door liners and gaskets	Sponge, soft cloth or paper towel with mild detergent and warm water	<ul style="list-style-type: none"> • Wash, rinse and dry thoroughly. DO NOT USE cleaning waxes, concentrated detergents, bleaches or cleaners containing petroleum on plastic parts.
Plastic parts (covers and panels)	Soft, clean sponge or soft, clean cloth with mild detergent and warm water	<ul style="list-style-type: none"> • Wash, rinse and dry thoroughly. DO NOT USE paper towels, window sprays, scouring cleansers or flammable fluids. These can scratch or damage material. See "Important Safety Instructions" on page 3.
Defrost pan	Sponge or cloth with mild detergent and warm water	<ul style="list-style-type: none"> • Remove base grille. (See page 17.) • To remove defrost pan, lift pan over wire brace (remove tape; if any). • Wash, rinse and dry thoroughly. • Replace with notched corner to the rear. Push it in all the way. • Make sure defrost pan drain tube is pointing into pan. • Replace base grille.
Condenser coils	Vacuum cleaner with extended narrow attachment	<ul style="list-style-type: none"> • Remove base grille. • Vacuum coils when dusty or dirty. Coils may need to be cleaned as often as every other month. • Replace base grille.
Floor under refrigerator	Floor cleaners	<ul style="list-style-type: none"> • Roll refrigerator out only as far as the water supply line allows. • Clean floor. • Roll refrigerator back into place. • Check to see if the refrigerator is level.

Vacation and moving care

Short vacations

No need to shut off the refrigerator if you will be away for less than four weeks.

1. Use up any perishables.
2. Freeze other items.
3. Raise ice maker signal arm to OFF (up) position.
4. Shut off water supply to icemaker.
5. Empty the ice bin.

Long vacations

If you will be gone a month or more:

1. Remove all food from the refrigerator.
2. Turn off the water supply to the ice maker at least one day ahead of time.
3. When the last load of ice drops, turn off the ice maker. Make sure all ice has dispensed out of the ice maker mechanism.
4. Unplug the refrigerator.
5. Clean it, rinse well and dry.
6. Tape rubber or wood blocks to the tops of both doors to prop them open far enough for air to get in. This stops odor and mold from building up.

Moving

When you are moving the refrigerator to a new home:

1. Turn off the water supply to the ice maker at least one day ahead of time.
2. Disconnect the water line.
3. After the last load of ice drops, lift the signal arm to the OFF (up) position.
4. Remove all food from the refrigerator.
5. Pack all frozen food in dry ice.
6. Unplug the refrigerator.
7. Clean it thoroughly. Rinse well and dry.
8. Take out all removable parts, wrap them well, and tape them together so they don't shift and rattle.
9. Screw in the leveling rollers.
10. Tape the doors shut and tape the power supply cord to the cabinet.

When you get to your new home, put everything back and refer to page 5. Also, remember to reconnect the water supply line.

WARNING

Personal Injury Hazard

Do not allow children to climb on, play near or climb inside the refrigerator when the doors are blocked open.

They may become injured or trapped.

To restart refrigerator, see "Using Your Refrigerator" on page 7.

Power interruptions

If electricity goes off, call the power company. Ask how long power will be off.

1. If service will be interrupted 24 hours or less, **keep both doors closed**. This helps food stay frozen.
2. If service will be interrupted longer than 24 hours:
 - (a) Remove all frozen food and store in a frozen food locker.

OR

- (b) Place 2 lbs. (0.9 kg) of dry ice in freezer for every cubic foot of freezer space. This will keep food frozen for 2 to 4 days. Wear gloves to protect your hands from dry ice burns.

OR

- (c) If neither a food locker or dry ice is available, use or can perishable food at once.
3. A full freezer stays cold longer than a partly filled one. A freezer full of meat stays cold longer than a freezer full of baked goods. If food contains ice crystals, it may be safely refrozen, although the quality and flavor may be affected. If the condition of the food is poor, or if you feel it is unsafe, dispose of it.

Questions ?

Call our Consumer Assistance Center telephone number, 1-800-253-1301.

Food Storage Guide

There is a correct way to package and store refrigerated or frozen food. To keep food fresher, longer, take the time to study these recommended steps.

Storing fresh food

Wrap or store food placed in the refrigerator in airtight and moisture-proof material. This prevents food odor and taste transfer throughout the refrigerator. For dated products, check code date to ensure freshness.

Leafy vegetables

Remove store wrapping and trim or tear off bruised and discolored areas. Wash in cold water and drain. Place in plastic bag or plastic container and store in crisper.

Vegetables with skins (carrots, peppers)

Store in crisper, plastic bags or plastic container.

Fruit

Wash, let dry and store in refrigerator in plastic bags or crisper. Do not wash or hull berries until they are ready to use. Sort and keep berries in their original container in a crisper, or store in a loosely closed paper bag on a refrigerator shelf.

Eggs

Store without washing in egg bin provided, or in the original carton on an interior shelf.

Milk

Wipe milk cartons. For best storage, place milk on interior shelf.

Butter or margarine

Keep opened butter in covered dish or closed compartment. When storing an extra supply, wrap in freezer packaging and freeze.

Cheese

Store in the original wrapping until you are ready to use it. Once opened, rewrap tightly in plastic wrap or aluminum foil.

Leftovers

Cover leftovers with plastic wrap or aluminum foil. Plastic containers with tight lids can also be used.

Meat

Store most meat in original wrapping as long as it is airtight and moisture-proof. Rewrap if necessary. See the following chart for storage times.

TYPE	APPROXIMATE TIME (DAYS)*
Chicken	1 to 2
Ground beef	1 to 2
Steaks and roasts	3 to 5
Cured meats	7 to 10
Bacon	5 to 7
Cold cuts	3 to 5
Variety meats	1 to 2

*If storing meat longer than the times given, follow the directions for freezing.

NOTE: Use fresh fish and shellfish the same day as purchased.

Storing frozen food

The freezer section is designed for storage of commercially frozen food and for freezing food at home.

NOTE: For further information about preparing food for freezing or food storage times, contact your local Cooperative Extension Service or check a freezer guide or reliable cookbook.

Packaging

The secret of successful freezing is in the packaging. The way you close and seal the package must not allow air or moisture in or out. Packaging done in any other way could cause food odor and taste transfer throughout the refrigerator and drying of frozen food.

Packaging recommended for use:

- Rigid plastic containers with tight-fitting lids
- Straight-sided canning/freezing jars
- Heavy-duty aluminum foil
- Plastic-coated paper
- Non-permeable plastic wraps (made from a saran film)

Follow package or container instructions for proper freezing methods.

Do not use:

- Bread wrappers
- Non-polyethylene plastic containers
- Containers without tight lids
- Waxed paper
- Waxed-coated freezer wrap
- Thin, semi-permeable wrap

The use of these wrappings could cause food odor, taste transfer and drying of frozen food.

Freezing

Do not expect your freezer to quick-freeze any large quantity of food. Put no more unfrozen food into the freezer than will freeze within 24 hours (no more than 2 to 3 pounds of food per cubic foot of freezer space). Leave enough space for air to circulate around packages. Be careful to leave enough room at the front so the door can close tightly.

Storage times will vary according to the quality of the food, the type of packaging or wrap used (airtight and moisture-proof) and the storage temperature, which should be 0°F (-17.8°C).

If You Need Assistance Or Service

Performance problems often result from little things you can fix without tools. Please read the chart below before calling for service on your appliance.

1. Before calling for assistance ...

Listed in this chart are the most common problems consumers run into with their appliances. Please read through this and see if it can solve your problem.

PROBLEM	CHECK THE FOLLOWING
Your refrigerator will not operate	<p>Is the power supply cord firmly plugged into a live circuit with proper voltage?</p> <p>Has a household fuse or circuit breaker blown/tripped?</p> <p>Is the Refrigerator Control set to the OFF position?</p>
The lights do not work	<p>Is the power supply cord firmly plugged into a live circuit with proper voltage?</p> <p>Has a household fuse or circuit breaker blown/tripped?</p> <p>Is a bulb burned out?</p>
The ice maker does not work	<p>Is the freezer cold enough to make ice? It could take overnight for the freezer to reach the proper temperature.</p> <p>Is the ON/OFF lever in the ON (down) position? (See page 14.)</p> <p>Is the water valve turned on?</p> <p>Does the water line have a clog or leak?</p>
You hear unfamiliar sounds or a rattling/jingling noise	<p>Is something on top of or behind the refrigerator?</p> <p>Some new sounds are normal. See "Understanding the sounds you may hear" on page 19.</p>
There is water in the defrost pan	<p>This is normal on hot, muggy days. Make sure the refrigerator is level so the pan does not overflow.</p>
The motor seems to run too much	<p>Are the condenser coils dirty?</p> <p>Has the door been opened often? Has a large amount of food been added at one time? The motor naturally runs longer if these things happen.</p> <p>Is the room hot? If the room is too warm, the motor runs longer to keep the unit cool.</p>

IF YOU NEED ASSISTANCE OR SERVICE

2. If you need assistance* ...

Call Whirlpool Consumer Assistance Center telephone number. Dial toll-free from anywhere in the U.S.A.:

1-800-253-1301

and talk with one of our trained consultants. The consultant can instruct you in how to obtain satisfactory operation from your appliance or, if service is necessary, recommend a qualified service company in your area.

If you prefer, write to:

Mr. William Clark
Consumer Assistance Representative
Whirlpool Corporation
2000 M-63
Benton Harbor, MI 49022

Please include a daytime phone number in your correspondence.

3. If you need service* ...

Whirlpool has a nationwide network of authorized Whirlpool® service companies. Whirlpool service technicians are trained to fulfill the product warranty and provide after-warranty service, anywhere in the United States. To locate the authorized Whirlpool service company in your area, call our Consumer Assistance Center telephone number (see Step 2) or look in your telephone directory Yellow Pages under:

• APPLIANCE-HOUSEHOLD-
MAJOR, SERVICE & REPAIR
- See: Whirlpool Appliances or
Authorized Whirlpool Service
(Example: XYZ Service Co.)

• WASHING MACHINES &
DRYERS, SERVICE & REPAIR
- See: Whirlpool Appliances or
Authorized Whirlpool Service
(Example: XYZ Service Co.)

4. If you need FSP® replacement parts ...

FSP is a registered trademark of Whirlpool Corporation for quality parts. Look for this symbol of quality whenever you need a replacement part for your Estate® appliance. FSP replacement parts will fit right and work right, because they are made to the same exacting specifications used to build every new Estate appliance.

To locate FSP replacement parts in your area, refer to Step 3 above or call the Whirlpool Consumer Assistance Center number in Step 2.

5. If you are not satisfied with how the problem was solved ...

- Contact the Major Appliance Consumer Action Panel (MACAP). MACAP is a group of independent consumer experts that voices consumer views at the highest levels of the major appliance industry.
- Contact MACAP only when the dealer, authorized servicer and Whirlpool have failed to resolve your problem.
Major Appliance Consumer Action Panel
20 North Wacker Drive
Chicago, IL 60606
- MACAP will in turn inform us of your action.

*When asking for help or service:

Please provide a detailed description of the problem, your appliance's complete model and serial numbers, and the purchase date. (See page 2.) This information will help us respond properly to your request.

ESTATE[®] Refrigerator Warranty

LENGTH OF WARRANTY	WHIRLPOOL WILL PAY FOR						
FULL ONE-YEAR WARRANTY From Date of Purchase	FSP [®] replacement parts and repair labor to correct defects in materials or workmanship. Service must be provided by an authorized Whirlpool service company.						
FULL FIVE-YEAR WARRANTY From Date of Purchase	FSP replacement parts and repair labor to correct defects in materials or workmanship in the sealed refrigeration system. These parts are: <table style="margin-left: 40px; border: none;"> <tr> <td>1. Compressor</td> <td>4. Drier</td> </tr> <tr> <td>2. Evaporator</td> <td>5. Connecting tubing</td> </tr> <tr> <td>3. Condenser</td> <td></td> </tr> </table> Service must be provided by an authorized Whirlpool service company.	1. Compressor	4. Drier	2. Evaporator	5. Connecting tubing	3. Condenser	
1. Compressor	4. Drier						
2. Evaporator	5. Connecting tubing						
3. Condenser							
WHIRLPOOL WILL NOT PAY FOR							
<p>A. Service calls to:</p> <ol style="list-style-type: none"> 1. Correct the installation of your refrigerator. 2. Instruct you how to use your refrigerator. 3. Replace house fuses or correct house wiring or plumbing. 4. Replace light bulbs. <p>B. Repairs when your refrigerator is used in other than normal, single-family household use.</p> <p>C. Pickup and delivery. Your refrigerator is designed to be repaired in the home.</p> <p>D. Damage to your refrigerator caused by accident, misuse, fire, flood, acts of God or use of products not approved by Whirlpool.</p> <p>E. Any food loss due to product failure.</p> <p>F. Repairs to parts or systems caused by unauthorized modifications made to the appliance.</p>							

5-93

WHIRLPOOL CORPORATION SHALL NOT BE LIABLE FOR INCIDENTAL OR CONSEQUENTIAL DAMAGES. Some states do not allow the exclusion or limitation of incidental or consequential damages, so this limitation or exclusion may not apply to you. This warranty gives you specific legal rights, and you may also have other rights which vary from state to state.

Outside the United States, a different warranty may apply. For details, please contact your authorized Whirlpool distributor or military exchange.

If you need service, first see the "Assistance or Service" section of this book. After checking "Assistance or Service," additional help can be found by calling our Consumer Assistance Center telephone number, 1-800-253-1301, from anywhere in the U.S.A.



Printed on recycled paper—
10% post-consumer waste
50% recovered materials

PART NO. 2173153

© 1994 Whirlpool Corporation

© Registered Trademark of Whirlpool Corporation.

Printed in U.S.A.